





















Genata POE SWITCH



No.	Model	Description	Picture	SRP	DP
1	GNT-P9105ES	<p>4FE+1FE(UP-LINK)</p> <ul style="list-style-type: none"> ■ 1*100Mbps Up-link +4*100Mbps PoE port ■ Ports(1-3)Support IEEE 802.3af/at protocol ■ Ports(4)Support IEEE 802.3af/at/bt 60Wprotocol ■ 6KV Lightning protection,8KV electro-static protection,Short-circuit protection,Over-Temperature protection,Preventing surge ■ Bandwidth:1Gbps ■ Max transmission distance: 100M(100Mbps) ■ Power input: AC 180~240V / 		P1,470	P920
2	GNT-P9210ES	<p>8FE+2FE(UP-LINK)</p> <ul style="list-style-type: none"> ■ 2*100Mbps Up-link +8*100Mbps PoE port ■ Ports(1-6)Support IEEE 802.3af/at protocol ■ Ports(7-8)Support IEEE 802.3af/at/bt 60Wprotocol ■ 6KV Lightning protection,8KV electro-static protection,Short-circuit protection,Over-Temperature protection,Preventing surge ■ Bandwidth:2Gbps ■ Max transmission distance: 100M(100Mbps) ■ Power input: AC 180~240V / 		P2,450	P1,520
3	GNT-P9206EA	<p>4FE+2FE(UP-LINK)</p> <ul style="list-style-type: none"> ■ 2*100Mbps Up-link +4*100Mbps PoE port ■ Ports(1-3)Support IEEE 802.3af/at protocol ■ Ports(4)Support IEEE 802.3af/at/bt 60Wprotocol ■ 6KV Lightning protection,8KV electro-static protection,Short-circuit protection,Over-Temperature protection,Preventing surge ■ Bandwidth:1.2Gbps ■ Max transmission distance: 130M(100Mbps)/250M(10Mbps) ■ Power input: AC 180~240V / 65W / 50~60Hz 		P2,200	P1,375





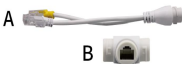

4	GNT-P9828V6	<p>8FE(PoE)+2FE(UP-LINK) AI PoE Switch</p> <ul style="list-style-type: none"> ■ 2*100Mbps up-link +8*10Mbps/100Mbps PoE port ■ Ports(1-6)Support IEEE 802.3af/at protocol ■ Ports(7-8)Support IEEE 802.3af/at/bt 60W protocol ■ Max transmission distance: Ports(1-2)250M(10Mbps) <p>Ports(3-8)130M(100Mbps)</p> <ul style="list-style-type: none"> ■ Power input: AC 180~240V / 		P3,100	P1,950
5	GNT-P1210SG	<p>8FE(PoE)+2GE(UP-LINK) AI Hybrid PoE Switch</p> <ul style="list-style-type: none"> ■ 2*1000Mbps Uplink ports + 8*100Mbps PoE ports ■ Ports(1-6) Support IEEE 802.3af/at protocol, ■ Ports(7-8) Support IEEE 802.3af/at/bt 60W protocol ■ Max transmission distance: 130 m ■ Power input: AC 180~240V / 120W / 50~60Hz 		P3,660	P2,300
6	GNT-P4804V6	<p>6FE&2GE+2GE(UP-LINK) +1SFP</p> <ul style="list-style-type: none"> ■ 1*1000Mbps SFP Port+2*1000Mbps Uplink+2*1000Mbps PoE (Compatible uplink) + 6*100Mbps PoE ports ■ Ports(1-6)Support IEEE 802.3af/at protocol ■ Ports(7-8)Support IEEE 802.3af/at/bt 60W protocol ■ Max transmission distance: 130 m 		P4,800	P3,000
7	GNT-P4813V6	<p>15FE & 1GE+2GE(UP-LINK)+1SFP</p> <ul style="list-style-type: none"> ■ 1*1000Mbps SFP Port+2*1000Mbps Uplink ports +1* 1000Mbps PoE port(Compatible uplink) + 15*100Mbps PoE ports ■ Ports(1-14)Support IEEE 802.3af/at protocol ■ Ports(15-16)Support IEEE 802.3af/at/bt 60W protocol ■ Bandwidth: 11Gbps. ■ Max transmission distance: 250m ■ Power input: AC 180~240V / 300W / 50~60Hz 		P8,900	P5,570
8	GNT-P4815V6	<p>22FE(PoE)+2GE(PoE)+2GE(UP-LINK) AI Hybrid PoE Switch</p> <ul style="list-style-type: none"> ■ 2*1000Mbps Uplink ports +2* 1000Mbps PoE port(Compatible uplink) + 22*100Mbps PoE ports ■ Ports(1-22)Support IEEE 802.3af/at protocol ■ Ports(23-24)Support IEEE 802.3af/at/bt 60W protocol 		P11,150	P7,000





9	GNT-P1006GA	<p>4GE(POE)+1GE(UP-LINK)+1SFP AI Gigabit PoE Switch</p> <ul style="list-style-type: none"> ■1*1000Mbps up-link +SFP+4*1000Mbps PoE port ■Ports(1-3)Support IEEE 802.3af/at protocol ■Ports(4)Support IEEE 802.3af/at/ bt 60W protocol ■Bandwidth:12Gbps ■Max transmission distance: 130M(100Mbps) ■Power input: AC180V~240V / 65W / 50~60Hz 		P4,400	P2,750
10	GNT-P1210G7	<p>8GE(POE)+2GE(UP-LINK)</p> <ul style="list-style-type: none"> * Support IEEE802.3af/at/ bt 60W * 6KV lightning protection, 8KV Electro-Static,surge protection,anti-reverse connection, overcurrent protection, over-voltage protection,over-temperature protection, Short circuit protection * PoE Port: Port(1~8)*1000M * PoE++ Port: bt Port(7~8) 60W * Power: 120W * Transmission Distance: 130m 		P7,000	P4,400
11	GNT-P1012G6	<p>8GE(PoE)+2GE(UP-LINK)+2SFP AI Gigabit PoE Switch</p> <ul style="list-style-type: none"> ■2*1000Mbps SFP Port+2*1000Mbps Uplink ports +8*1000Mbps PoE ports ■Ports(1-6)Support IEEE 802.3af/at protocol ■Ports(7-8)Support IEEE 802.3af/at/ bt 60W protocol ■Max transmission distance: 130 m ■Power input: AC 180~240V / 120W / 50~60Hz 		P7,800	P4,900
12	GNT-P1018G6	<p>16GE(PoE)+2SFP AI Gigabit PoE Switch</p> <ul style="list-style-type: none"> ■2*1000Mbps SFP Port+16*1000Mbps PoE ports ■Ports(1-14)Support IEEE 802.3af/at protocol ■Ports(15-16)Support IEEE 802.3af/at/ bt 60W protocol ■Bandwidth: 36Gbps. ■Max transmission distance: 130 m ■Power input: AC 180~240V / 300W / 50~60Hz 		P12,000	P7,500

13	GNT-P1026G6	<p>24GE(PoE)+2SFP AI Gigabit PoE Switch</p> <ul style="list-style-type: none"> ■2*1000Mbps SFP Port+4*1000Mbps PoE ports(Compatible uplink)+20*1000Mbps PoE ports ■Ports(1-22)Support IEEE 802.3af/at protocol ■Ports(23-24)Support IEEE 802.3af/at/bt 60W protocol ■Bandwidth: 52Gbps. ■Max transmission distance: 130 m 		P18,000	P11,250
14	GNT-9828F6	<p>8FE(PoE)+2FE(UP-LINK) AI Waterproof Switch</p> <ul style="list-style-type: none"> ■2*100Mbps up-link +8*10Mbps/100Mbps PoE port ■Ports(1-6)Support IEEE 802.3af/at protocol ■Ports(7-8)Support IEEE 802.3af/at/bt 60W protocol ■Max transmission distance: Ports(1-2)250M(10Mbps) Ports(3-8)130M(100Mbps) ■Power input: AC:AC 180~240V / 130W / EA 60W 		P4,300	P2,700
15	GNT-P4804F6	<p>6FE(PoE)+2GE(PoE)+2GE(UP-LINK)+1SFP AI Hybrid Waterproof PoE Switch</p> <ul style="list-style-type: none"> ■1*1000Mbps SFP Port+2*1000Mbps Uplink+2*1000Mbps PoE (Compatible uplink) + 6*100Mbps PoE ports ■Ports(1-6)Support IEEE 802.3af/at protocol ■Ports(7-8)Support IEEE 802.3af/at/bt 60W protocol 		P5,800	P3,650
16	GNT-P1012G6-F	<p>8GE(PoE)+2GE(PoE)+2SFP AI Gigabit Waterproof PoE Switch</p> <ul style="list-style-type: none"> ■2*1000Mbps SFP Port+2*1000Mbps Uplink ports +8*1000Mbps PoE ports ■Ports(1-6)Support IEEE 802.3af/at protocol ■Ports(7-8)Support IEEE 802.3af/at/bt 60W protocol ■LAN(1~2):10/100/1000Mbps uplink ports (RJ45) ■SFP(1~2):10/100/1000Mbps SFP ports ■Max transmission distance: 130 m 		P8,400	P5,300

17	GNT-P1012F6	8GE(PoE)+2GE(PoE)+2SFP AI Gigabit Waterproof PoE Switch ■2*1000Mbps SFP Port+2*1000Mbps Uplink ports +8*1000Mbps PoE ports ■Ports(1-6)Support IEEE 802.3af/at protocol ■Ports(7-8)Support IEEE 802.3af/at/bt 60W protocol ■Max transmission distance: 130 m ■Power input: AC 180~240V / 120W		P7,200	P4,500
18	GNT-P4813F6	15FE & 1GE+2GE(UP-LINK)+1SFP ■1*1000Mbps SFP Port+2*1000Mbps Uplink ports +1*1000Mbps PoE port(Compatible uplink) + 15*100Mbps PoE ports ■Ports(1-14)Support IEEE 802.3af/at protocol ■Ports(15-16)Support IEEE 802.3af/at/ bt 60w protocol ■Mac Address: 8K ■Max transmission distance: 250m AC 180~240V		P14,000	P8,750
19	GNT-P4815F6	22FE(PoE)&2GE(PoE)+2GE(UP-LINK) AI Hybrid Waterproof PoE Switch ■2*1000Mbps Uplink ports +2*1000Mbps PoE port(Compatible uplink) + 22*100Mbps PoE ports ■Ports(1-22)Support IEEE 802.3af/at protocol ■Ports(23-24)Support IEEE 802.3af/at/ bt 60W protocol ■Max transmission distance: 130 m AC 180~240V		P17,000	P10,600
20	GNT-69P31	3 Ports Cascade UPoE Extend Switch		P1,180	P740
21	GNT-6FP31	3 Ports Outdoor Cascade UPoE Extend Switch		P1,360	P850
22	GNT-5313AB	PoE Synthesizer separator Converter		P300	P180

23	GNT-5313Cover	Four set waterproof Cover (Optional)		P100	P65
24	GNT-P0602FMI	Industrial-Grade 4GE+2SFP Gigabit Managed PoE Switch ■2*1000Mbps SFP Ports+ 4*1000Mbps Ports+1 * RS232 console port ■Support Web-based network management, support VLAN, QoS, RSTP, SNMP etc. network function ■Ports(1-4)Support IEEE 802.3af/at protocol ■Switching Capacit: 12Gbps ■Power Consumption:		P10,800	P6,750
25	GNT-P1002FMI	Industrial-Grade 8GE+2SFP Gigabit Managed PoE Switch ■2*1000Mbps SFP Ports+8*1000Mbps PoE Ports 1 * RS232 console port(115200,N,8,1) ■Support Web-based network management, support VLAN, QoS, RSTP, SNMP etc. network function ■Support IEEE 802.3af/at protocol ■Switching Capacit: 20Gbps ■Packet Forwarding Rate: 14.88Mpps		P21,600	P13,500
26	GNT-P1608FMI	Industrial-Grade 8GE+8SFP Gigabit Managed PoE Switch ■8*1000Mbps Combo Ports+8*1000Mbps PoE Ports , 1 * RS232 console port(115200,N,8,1) ■Support Web-based network management, support VLAN, QoS, RSTP, SNMP etc. network function ■Support IEEE 802.3af/at protocol ■Switching Capacit: 32Gbps ■Packet Forwarding Rate: 22.88Mpps		P35,000	P22,000

27	GNT-IG1210FP-AC	<p>Industrial 8 Port Full Gigabit Unmanaged PoE Switch</p> <ul style="list-style-type: none"> ■8*1000Mbps PoE Ports+2*1000Mbps SFP ■Input: 90-264V AC,DC48-52V Triple Redundancy ■Port: (1-6port) Support IEEE 802.3af/at protocol, (7-8port) Support IEEE 802.3af/at/bt 60W protocol ■Protection level: IP40 ■6KV Lightning protection 		₱10,800	₱6,750
28	GNT-IG1218FP-AC	<p>Industrial 16 Port Full Gigabit Unmanaged PoE Switch</p> <ul style="list-style-type: none"> ■16*1000Mbps PoE Ports+2*1000Mbps SFP ■Input: 90-264V AC ;DC48-52V Triple Redundant ■Port: (1-6port,9-14port) Support IEEE 802.3af/at protocol, (7-8port,15-16port) Support IEEE 802.3af/at/bt 60W protocol ■Protection level: IP40 ■6KV Lightning protection 		₱23,000	₱14,500
29	GNT-IDC45F4	Industrial waterproof box Fan+Air Switch		₱6,900	₱4,300
30	GNT-69P51G6	<p>4GE(PoE)+1GE(UP-LINK) PoE Extend Switch</p> <ul style="list-style-type: none"> ■1*1000Mbps Uplink ports +4*1000Mbps PoE port ■support cascade 2 times ■Ports(1-3)Support IEEE 802.3af/at protocol ■Ports(4)Support IEEE 802.3af/at/bt protocol 		₱1,700	₱1,080
31	GNT-6FP51G6	<p>4GE(PoE)+1GE(UP-LINK) Waterproof PoE Extend Switch</p> <ul style="list-style-type: none"> ■1*1000Mbps Uplink ports +4*1000Mbps PoE port 		₱1,900	₱1,200
32	GNT-P2903AB	<ul style="list-style-type: none"> ■Transmission Range :20KM ■Transmission Rate:100Mbps ■Operating Voltage :DC 12V0.4A or PoE ■Overall Power:<3W ■Optical Port: SC ■Wavelength: Single-Mode: 1310/1550nm ■Working Mode: Full/half duplex 		₱2,300	₱1,450

33	GNT-P2913AB	<ul style="list-style-type: none"> ■Transmission Range :3KM ■Transmission Rate:1000Mbps ■Operating Voltage : DC 12V0.4A or PoE ■Overall Power:<3W ■Optical Port: CS ■Wavelength: Single-Mode: 1310/1550nm ■Working Mode: Full/half duplex 		P3,300	P2,050
34	GNT-G922SAB	<p>Industrial-Grade FE 20KM Media Converter</p> <ul style="list-style-type: none"> ■Transmission Range :20KM ■Transmission Rate:100Mbps ■Wide Input Voltage :DC 5V1A or 12V 0.4A ■Compatible With 5521 5525 ■Overall Power:≤5W ■Optical Port: SC ■Wavelength:1310/1550nm ■Working Mode: Full/half duplex supported ■Single Mode Single Core ■A&B Device Port: 1*SC 		P2,500	P1,600
35	GNT-G120SAB	<p>Industrial-Grade GE 3KM Media Converter</p> <ul style="list-style-type: none"> ■Transmission Range :3KM ■Transmission Rate:1000Mbps ■Wide Input Voltage :DC 5V1A or 12V 0.4A ■Compatible With 5521 5525 ■Overall Power:≤5W ■Optical Port: SC ■Wavelength:1310/1550nm ■Working Mode: Full/half duplex supported ■Single Mode Single fiber 		P3,400	P2,200
36	GNT-G122SAB	<p>Industrial-Grade GE 20KM Media Converter</p> <ul style="list-style-type: none"> ■Transmission Range :20KM ■Transmission Rate:1000Mbps ■Wide Input Voltage :DC 5V1A or 12V 0.4A ■Compatible With 5521 5525 ■Overall Power:≤5W ■Optical Port: SC ■Wavelength:1310/1550nm ■Working Mode: Full/half duplex supported ■Single Mode Single Core 		P3,900	P2,500
37	GNT-5805G	<p>50M Fiber Optical</p> <ul style="list-style-type: none"> ■Plug:SC-SC ■Attenuation :0.028Db/KM ■Single-mode Single-core fiber ■Mode field diameter:1310/1550nm ■Fiber Core:G.652D ■Connections: 10 times 		P1,440	P900

38	GNT-5810G	100M Fiber Optical ■Plug:SC-SC ■Attenuation :0.028Db/KM ■Single-mode Single-core fiber ■Mode field diameter:1310/1550nm ■Fiber Core:G.652D ■Connections: 10 times		₱2,160	₱1,350
39	GNT-5815G	150M Fiber Optical ■Plug:SC-SC ■Attenuation :0.028Db/KM ■Single-mode Single-core fiber ■Mode field diameter:1310/1550nm ■Fiber Core:G.652D ■Connections: 10 times		₱3,100	₱2,000
40	GNT-5820G	200M Fiber Optical ■Plug:SC-SC ■Attenuation :0.028Db/KM ■Single-mode Single-core fiber ■Mode field diameter:1310/1550nm ■Fiber Core:G.652D ■Connections: 10 times		₱3,800	₱2,400
41	GNT-5825G	250M Fiber Optical ■Plug:SC-SC ■Attenuation :0.028Db/KM ■Single-mode Single-core fiber ■Mode field diameter:1310/1550nm ■Fiber Core:G.652D ■Connections: 10 times		₱4,600	₱2,900
42	GNT-5830G	300M Fiber Optical ■Plug:SC-SC ■Attenuation :0.028Db/KM ■Single-mode Single-core fiber ■Mode field diameter:1310/1550nm ■Fiber Core:G.652D ■Connections: 10 times		₱5,400	₱3,380
43	GNT-5505G	50M Fiber Optical ■Plug:SC-SC ■Attenuation :0.028Db/KM ■Single-mode Double-core fiber ■Mode field diameter:1310/1550nm ■Fiber Core:G.652D ■Connections: 10 times		₱2,000	₱1,250
44	GNT-5510G	100M Fiber Optical ■Plug:SC-SC ■Attenuation :0.028Db/KM ■Single-mode Double-core fiber ■Mode field diameter:1310/1550nm ■Fiber Core:G.652D ■Connections: 10 times		₱3,000	₱1,875
45	GNT-5515G	150M Fiber Optical ■Plug:SC-SC ■Attenuation :0.028Db/KM ■Single-mode Double-core fiber ■Mode field diameter:1310/1550nm ■Fiber Core:G.652D ■Connections: 10 times		₱4,000	₱2,500





46	GNT-5520G	200M Fiber Optical ■Plug:SC-SC ■Attenuation :0.028Db/KM ■Single-mode Double-core fiber ■Mode field diameter:1310/1550nm ■Fiber Core:G.652D ■Connections: 10 times		₱5,000	₱3,200
47	GNT-5525G	250M Fiber Optical ■Plug:SC-SC ■Attenuation :0.028Db/KM ■Single-mode Double-core fiber ■Mode field diameter:1310/1550nm ■Fiber Core:G.652D ■Connections: 10 times		₱5,800	₱3,650
48	GNT-5530G	300M Fiber Optical ■Plug:SC-SC ■Attenuation :0.028Db/KM ■Single-mode Double-core fiber ■Mode field diameter:1310/1550nm ■Fiber Core:G.652D ■Connections: 10 times		₱6,800	₱4,250
49	GNT-5605	50M Fiber Optical with Power cable ■Plug:SC-SC ■Attenuation :0.028Db/KM ■Single-mode Double-core fiber ■Mode field diameter:1310/1550nm ■Fiber Core:G.652D ■Connections: 10 times		₱4,000	₱2,500
50	GNT-5610	100M Fiber Optical with Power cable ■Plug:SC-SC ■Attenuation :0.028Db/KM ■Single-mode Double-core fiber ■Mode field diameter:1310/1550nm ■Fiber Core:G.652D ■Connections: 10 times		₱6,500	₱4,080
51	GNT-5615	150M Fiber Optical with Power cable ■Plug:SC-SC ■Attenuation :0.028Db/KM ■Single-mode Double-core fiber ■Mode field diameter:1310/1550nm ■Fiber Core:G.652D ■Connections: 10 times		₱9,200	₱5,750
52	GNT-5620	200M Fiber Optical with Power cable ■Plug:SC-SC ■Attenuation :0.028Db/KM ■Single-mode Double-core fiber ■Mode field diameter:1310/1550nm ■Fiber Core:G.652D ■Connections: 10 times		₱12,000	₱7,500



53	GNT-5625	250M Fiber Optical with Power cable ■Plug:SC-SC ■Attenuation :0.028Db/KM ■Single-mode Double-core fiber ■Mode field diameter:1310/1550nm ■Fiber Core:G.652D ■Connections: 10 times		P14,400	P9,000
54	GNT-5630	300M Fiber Optical with Power cable ■Plug:SC-SC ■Attenuation :0.028Db/KM ■Single-mode Double-core fiber ■Mode field diameter:1310/1550nm ■Fiber Core:G.652D ■Connections: 10 times		P17,600	P11,000
55	GNT-GNT-10702-0.5	4K HDMI 2.0 Cable 4K Male to Male 0.5m 30AWG		P190	P120
56	GNT-10702-2	HDMI 2.0 Cable 4K Male to Male 2m 30AWG		P300	P190
57	GNT-10702-5	4K HDMI 2.0 Cable 4K Male to Male 5m 30AWG		P550	P350
58	GNT-10702-10	4K HDMI 2.0 Cable 4K Male to Male 10m 28AWG		P1,850	P1,150
59	GNT-10702-20	4K HDMI 2.0 Cable 4K Male to Male 20m amplified 28AWG		P4,300	P2,700

Itooner International Limited

Website:www.itoonertech.com

Non-PoE Switch

Product picture	Model	Description	SRP	SDP
	GNT-E9005EL	<p>5FE Unmanaged Megabytes Switch(Plastic case)</p> <ul style="list-style-type: none"> ■ 5*100Mbps port ■ 6KV Lightning protection,8KV electro-static protection,Short-circuit protection,Over-Temperature protection,Preventing surge ■ Bandwidth: 1Gbps ■ Mac address: 2K ■ Max transmission distance: 100M(100Mbps) ■ Power input: AC 90-264V ■ Size: 94*69*24mm 	₱851	₱567
	GNT-E9008EL	<p>8FE Unmanaged Megabytes Switch(Plastic case)</p> <ul style="list-style-type: none"> ■ 8*100Mbps port ■ 6KV Lightning protection,8KV electro-static protection,Short-circuit protection,Over-Temperature protection,Preventing surge ■ Bandwidth: 1.6Gbps ■ Mac address: 2K ■ Max transmission distance: 100M(100Mbps) ■ Power input: AC 90-264V ■ Size: 138*69*25mm 	₱1,075	₱717
	GNT-G1207FEL	<p>5GE+2SFP Unmanaged Gigabit Switch(Plastic case)</p> <ul style="list-style-type: none"> ■ 2*1000Mbps SFP Port+5*1000Mbps ports ■ 6KV Lightning protection,8KV electro-static protection,Short-circuit protection,Over-Temperature protection,Preventing surge ■ Bandwidth: 14Gbps. ■ Mac Address: 8K ■ Max transmission distance: 100M(1000Mbps) ■ Power input: AC 90-264V ■ Size: 138*69*25mm 	₱1,971	₱1,314
	GNT-G1005L	<p>5GE Unmanaged Gigabit Switch(Plastic case)</p> <ul style="list-style-type: none"> ■ 5*1000Mbps port ■ 6KV Lightning protection,8KV electro-static protection,Short-circuit protection,Over-Temperature protection,Preventing surge ■ Bandwidth: 10Gbps ■ Mac address: 8K ■ Max transmission distance: 100M(1000Mbps) ■ Power input: AC AC 90-264V ■ Size: 94*69*24mm 	₱1,252	₱835
	GNT-G1008L	<p>8GE Unmanaged Gigabit Switch(Plastic case)</p> <ul style="list-style-type: none"> ■ 8*1000Mbps ports ■ 6KV Lightning protection,8KV electro-static protection,Short-circuit protection,Over-Temperature protection,Preventing surge ■ Bandwidth: 16Gbps. ■ Mac Address: 8K ■ Max transmission distance: 100M(1000Mbps) ■ Power input: AC 90-264V ■ Size: 138*69*25mm 	₱2,141	₱1,427



	<p>GNT-G1018L</p>	<p>16GE+2SFP Unmanaged Gigabit Switch(Metal case)</p> <ul style="list-style-type: none"> ■ 2*1000Mbps SFP Port+16*1000Mbps ports ■ 6KV Lightning protection,8KV electro-static protection,Short-circuit protection,Over-Temperature protection,Preventing surge ■ Bandwidth: 36Gbps. ■ Mac Address: 8K ■ Max transmission distance: 100M(1000Mbps) ■ Power input: AC 90-264V ■ Size: 430*180*45mm 	<p>₱9,632</p>	<p>₱6,421</p>
	<p>GNT-G1026L</p>	<p>24GE+2SFP Unmanaged Gigabit Switch(Metal case)</p> <ul style="list-style-type: none"> ■ 2*1000Mbps SFP Port+24*1000Mbps ports ■ 6KV Lightning protection,8KV electro-static protection,Short-circuit protection,Over-Temperature protection,Preventing surge ■ Bandwidth: 52Gbps. ■ Mac Address: 8K ■ Max transmission distance:100M(1000Mbps) ■ Power input: AC 90-264V ■ Size: 430*180*45mm 	<p>₱12,096</p>	<p>₱8,064</p>



ITOOONER

Idea Transmission Navigator

Price List

Itooner International Limited

Model No.	Product Picture	Specification	SRP	SDP
GNT-L222KA		<p>22" LED Monitor</p> <ol style="list-style-type: none"> 1. LED Size: 21.5" LED 2. Aspect Ratio: 16:9 3. Max Resolution: 1920x1080; 4. View Angle:178°/178° 5. Brightness: 250cd/m²; 6. Dynamic contrast: 3000:1; 7. Response time: 6.5 ms; 8.Power Supply: DC12V 36W; 9.Installation: Desktop (Standard),wall-mounted,Pendant (Optional) 10. Input: VGA(D-15)*1, HDMI*1, Audio in*1 11. Packing Included: AC Cable, User Manual, HDMI Cable 	₱8,800.00	₱5,500.00
GNT-L324KA		<p>32" LED Monitor 4K</p> <ol style="list-style-type: none"> 1. LED Size: 32" LED; 2. Display Ratio: 16: 9 3. Max Resolution: 1920x1080; 4. View Angle:178°/178° 5. Brightness: 350cd/m²; 6. Dynamic contrast: 3000:1; 7. Response time: ≤9.5ms 8. Interface Type: VGA(D-15)*1, HDMI*1, AV*2, CVBS/Audio in*1, PC Audio In*1, USB*1 9.Power Supply: AC100-240V(±10%),50/60Hz 10.Installation: Desktop (Standard),Wall-mounted (Optional),Pendant (Optional),Embedded (Optional) 11. Packing included:AC Cable, HDMI Cable, Remote Control, A pair of battery; Usermanual, A pair of Pedestal (Left&Right), BA screws 	₱14,200.00	₱8,875.00

GNT-L434KA		<p>43" LED Monitor 4K</p> <ol style="list-style-type: none"> 1. LED Size: 43" LED; 2. Display Ratio: 16: 9 3. Max Resolution: 1920x1080; 4. View Angle:178°/178° 5. Brightness: 350cd/m²; 6. Dynamic contrast: 1200:1; 7. Response time: ≤8ms 8. Input:VGA(D-15)*1, HDMI*1, AV*2, CVBS/Audio in*1, PC Audio In*1, USB*1 9.Power Supply: AC100-240V(±10%),50/60Hz 10.Installation: Desktop (Standard),Wall-mounted (Optional),Pendant (Optional),Embedded (Optional) 11.Packing included:AC Cable, HDMI Cable, Remote Control, A pair of battery; Usermanual, A pair of Pedestal (Left&Right), BA screws 	₱19,700.00	₱12,312.50
GNT-L554KA		<p>55" LED Monitor 4K</p> <ol style="list-style-type: none"> 1. LED Size: 55" LED; 2. Display Ratio: 16: 9 3. Max Resolution: 3840x2160; 4. View Angle:178°/178° 5. Brightness: 400cd/m²; 6. Dynamic contrast: 1200:1; 7. Response time: ≤8ms 8. Input: VGA(D-15)*1, HDMI*1, DVI*1, AV*1, USB*2 9.Power Supply: AC100-240V(±10%),50/60Hz 10.Installation: Desktop (Standard),Wall-mounted (Optional),Pendant (Optional),Embedded (Optional) 11.Packing included:AC Cable, HDMI Cable, Remote Control, A pair of battery; Usermanual, A pair of Pedestal (Left&Right), BA screws 	₱49,000.00	₱30,625.00

GNT-L654KA		<p>65" LED Monitor 4K</p> <ol style="list-style-type: none"> 1. LED Size: 65" LED; 2. Display Ratio: 16: 9 3. Max Resolution: 3840x2160; 4. View Angle:178°/178° 5. Brightness: 400cd/m²; 6. Dynamic contrast:4000:1; 7. Response time: ≤6.5ms 8. Input: VGA(D-15)*1, HDMI*2, AV*1, DVI*1, Audio in*2, USB*1, RS232/IR*1 9. Power Supply: AC100-240V(±10%),50/60Hz 10. Installation: Desktop (Standard),Wall-mounted (Optional),Pendant (Optional),Embedded (Optional) 11. Packing included:AC Cable, HDMI Cable, Remote Control, A pair of battery; Usermanual, A pair of Pedestal(Left&Right), BA screws 	₱70,600.00	₱44,125.00
------------	-----------------------------------------------------------------------------------	------------------------------------------------------------------------------------------------------------------------------------------------------------------------------------------------------------------------------------------------------------------------------------------------------------------------------------------------------------------------------------------------------------------------------------------------------------------------------------------------------------------------------------------------------------------------------------------------------------------------------------------------------------------------------------------------------------------------------------	------------	------------





Anti-violent CCTV Monitor



Model No.	Product Picture	Specification	SRP	SDP
GNT-L754KG		<p>75" LED Anti-Violence Monitor 4K</p> <p>LED Size: 75" TFT LED Max Resolution: 3840X2160 Screen Ratio: 16:9 Viewing Angle: 178°/178° Brightness:400cd/m² Ports: HDMI*1 VGA*1 USB*2 DVI*1AV Shell: Metal shell Dimension:1708X989mm</p>	₱177,920.00	₱111,200.00



<p>GNT-L864KG</p>		<p>86" LED Anti-Violence Monitor 4K LED Size: 86" TFT LED Max Resolution: 3840X2160 Screen Ratio: 16:9 Viewing Angle: 178°/178° Brightness : 400cd/m² Ports : HDMI*1 VGA*1 USB*2 DVI*1AV Shell : Metal shell Dimension: 1950X1132mm</p>	<p>₱227,520.00</p>	<p>₱142,200.00</p>
<p>GNT-L984KG</p>		<p>98" LED Anti-Violence Monitor 4K LED Size: 98" TFT LED Max Resolution: 3840X2160 Screen Ratio: 16:9 Viewing Angle: 178°/178° Brightness: 400cd/m² Ports: HDMI*1 VGA*1 USB*2 DVI*1AV Shell: Metal shell Dimension: 2199X1259mm</p>	<p>₱449,920.00</p>	<p>₱281,200.00</p>



Interactive Flat Panel

Interactive Flat Panel (Education)

Model No.	Product Picture	Specification	SRP	SDP
GNT-J554KT		55" Interactive Flat Panel 4K ■ Resolution:3840*2160 ■ Color:10bit ture color(16.7M) ■ Screen Ration:16:9 ■ Angle:178°/178° ■ Brightness:350cd/m ² ■ Power Consumption: ≤90W ■ Dimension:1244*719mm	₱61,200.00	₱38,250.00
GNT-J654KT		65" Interactive Flat Panel 4K ■ Resolution:3840*2160 ■ Color:10bit ture color(16.7M) ■ Screen Ration:16:9 ■ Viewing Angle:178°/178° ■ Brightness:350cd/m ² ■ Power Consumption: ≤150W ■ Dimension:1461*838mm	₱110,000.00	₱68,750.00
GNT-J754KT		75" Interactive Flat Panel 4K ■ Resolution:3840*2160 ■ Color:10bit ture color(16.7M) ■ Screen Ration:16:9 ■ Viewing Angle:178°/178° ■ Brightness:350cd/m ² ■ Power Consumption: ≤230W ■ Dimension:1708*989mm	₱257,500.00	₱14,800.00
GNT-J864KT		86" Interactive Flat Panel 4K ■ Resolution:3840*2160 ■ Color:10bit ture color(16.7M) ■ Screen Ration:16:9 ■ Viewing Angle:178°/178° ■ Brightness:350cd/m ² ■ Power Consumption: ≤300W ■ Dimension:1950*1132mm	₱450,000.00	₱270,000.00

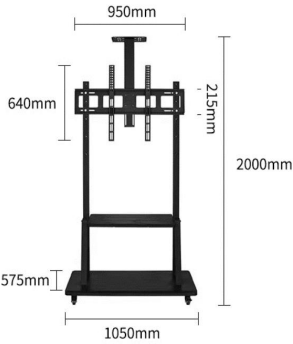
GNT-J984KT		<p>98" Interactive Flat Panel 4K</p> <ul style="list-style-type: none"> ■ Resolution:3840*2160 ■ Color:10bit ture color(16.7M) ■ Screen Ration:16:9 ■ Viewing Angle:178°/178° ■ Brightness:350cd/m² ■ Power Consumption: ≤400W ■ Dimension:2199*1259mm 	P770,000.00	P460,000.00
Interactive Flat Panel (Meeting) With Built-in camera				
Model No.	Product Picture	Specification	SRP	SDP
GNT-H654KT		<p>65" Interactive Flat Panel 4K</p> <ul style="list-style-type: none"> ■ Resolution:3840*2160 ■ Color:10bit ture color(16.7M) ■ Screen Ration:16:9 ■ Viewing Angle:178°/178° ■ Brightness:350cd/m² ■ Power Consumption: ≤150W ■ Dimension:1461*838mm Built-in camera 	P178,000.00	P111,250.00
GNT-H754KT		<p>75" Interactive Flat Panel 4K</p> <ul style="list-style-type: none"> ■ Resolution:3840*2160 ■ Color:10bit ture color(16.7M) ■ Screen Ration:16:9 ■ Viewing Angle:178°/178° ■ Brightness:350cd/m² ■ Power Consumption: ≤230W ■ Dimension:1708*989mm 	P280,000.00	P160,000.00

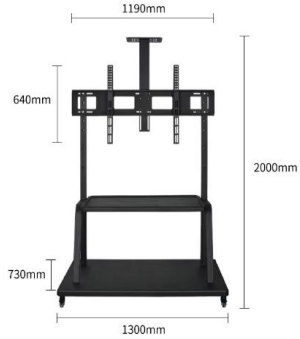

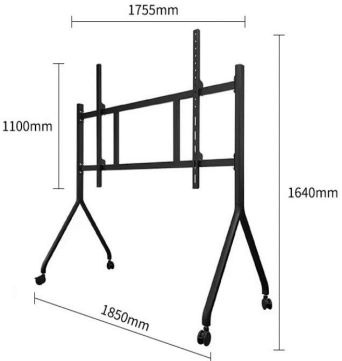

<p>GNT-H864KT</p>		<p>86" Interactive Flat Panel 4K</p> <ul style="list-style-type: none"> ■ Resolution:3840*2160 ■ Color:10bit ture color(16.7M) ■ Screen Ration:16:9 ■ Viewing Angle:178°/178° ■ Brightness:350cd/m² ■ Power Consumption: ≤300W ■ Dimension:1950*1132mm 	<p>₱480,000.00</p>	<p>₱286,000.00</p>
<p>GNT-H984KT</p>		<p>98" Interactive Flat Panel 4K</p> <ul style="list-style-type: none"> ■ Resolution:3840*2160 ■ Color:10bit ture color(16.7M) ■ Screen Ration:16:9 ■ Viewing Angle:178°/178° ■ Brightness:350cd/m² ■ Power Consumption: ≤400W ■ Dimension:2199*1259mm 	<p>₱830,000.00</p>	<p>₱496,000.00</p>
<p>GNT-LG3786</p>		<p>65inch~86inch Movable Stand</p> <ul style="list-style-type: none"> ■ Color:Black ■ Material: SPCC cold rolled steel ■ Product casters :306° swivel rubber casters ■ Product weight :28KG ■ Product casters :306° swivel rubber casters ■ Weight capacity: 240KG ■ Height adjustment: 1200-1700mm ■ Mounting pitch: 200*200-900*600mm ■ Plate thickness: column 50mm/hanging plate 2.5mm 	<p>₱7,000.00</p>	<p>₱4,375.00</p>

<p>GNT-LG3798</p>		<p>86inch~110inch Movable Stand</p> <ul style="list-style-type: none"> ■ Color:Black ■ Material: SPCC cold rolled steel ■ Product weight :46.2KG ■ Product casters :306° swivel rubber casters ■ Weight capacity: 260KG ■ Height adjustment: 1300-1500mm ■ Mounting pitch: 200*200-1100*600mm ■ Plate thickness: column 50mm/hanging plate 2.5mm 	<p>₱7,600.00</p>	<p>₱4,750.00</p>
<p>GNT-LG3886</p>		<p>65inch~86inch Movable Stand</p> <ul style="list-style-type: none"> ■ Color:matte silver ■ Material: cold rolled steel ■ Product weight :22KG ■ Product casters :306° swivel rubber casters ■ Weight capacity: 150KG ■ Height adjustment: 1300-1500mm ■ Mounting pitch: 200*200-1100*600mm ■ Center distance: 1150/1270/1380/1485mm ■ Plate thickness: D-shaped tube/hanging plate 2.2mm 	<p>₱7,000.00</p>	<p>₱4,375.00</p>

<p>GNT-LG3898</p>		<p>80inch~110inch Movable Stand</p> <ul style="list-style-type: none"> ■ Color:Black ■ Material: cold rolled steel ■ Product weight :38KG ■ Product casters :306°swivel rubber casters ■ Weight capacity: 300KG ■ Height adjustment: 1300-1500mm ■ Mounting pitch: 100*100-1600*1000mm ■ Center distance: 1150/1270/1380/1485 ■ Plate thickness: hook 2.5mm 	<p>₱7,600.00</p>	<p>₱4,750.00</p>
--------------------------	-----------------------------------------------------------------------------------	-----------------------------------------------------------------------------------------------------------------------------------------------------------------------------------------------------------------------------------------------------------------------------------------------------------------------------------------------------------------------------------------------------------------------------------------------------------	------------------	------------------

<p>GNT-DZS400</p>		<p>Screen Mirroring Device:</p> <ul style="list-style-type: none"> ■ Operating system: Windows 7 / 8.1 / 10 32 and 64 bits MAC OSX 10.10 / 10.11 / 10.12 / 10.13 and above Minimum requirements <ul style="list-style-type: none"> ■ Video input resolution:3840*2160 ■ H.264encoding resolution:1920*1080 ■ Wireless connection method: Insert the button to connect automatically, run automatically, share with one button, no need to install software on the computer, no need to occupy the computer Wi-Fi ■ Number of frames: 30/S ■ Audio:44.1KHz/16bit PCM, stereo ■ wireless transmission protocol :IEEE802.11ac/802.11n ■ Wireless transmission rate:867Mbps ■ Wireless transmission distance:30Meter ■ Wireless transmission frequency band:5.8G/2.4G ■ Wireless encryption protocol :WPA2-PSK <ul style="list-style-type: none"> ■ Transmission delay : 150ms ■ Video input resolution: 1920x1080 ■ Reverse control method: Support touch 16-point reverse control ■ Power Consumption: 5V*500mA, with an average power consumption of 1.5W <ul style="list-style-type: none"> ■ Run: -5°C ~ 40°C ■ Storage: -20°C ~ + 60°C 	<p>₱10,000.00</p>	<p>₱6,250.00</p>
--------------------------	-----------------------------------------------------------------------------------	-----------------------------------------------------------------------------------------------------------------------------------------------------------------------------------------------------------------------------------------------------------------------------------------------------------------------------------------------------------------------------------------------------------------------------------------------------------------------------------------------------------------------------------------------------------------------------------------------------------------------------------------------------------------------------------------------------------------------------------------------------------------------------------------------------------------------------------------------------------------------------------------------------------------------------------------------------------------------------------------------------------------------------------------------------------------------------------------------------------------------------------------------------------------------------------------------------------------------------------------------------------------------------------------------------------------------------------------------	-------------------	------------------

Idea Transmission Navigator Video Wall(Splicing Screen)

Model No.	Product Picture	Specification	SRP	SDP
CCTV Video Wall(Splicing Screen)				
GNT-PL46Q35		46" LED Splicing Screen (Full Cover) <ul style="list-style-type: none"> ■ Splicing Gap:3.5mm ■ Backlight Type:LED ■ Resolution:1920*1080 ■ Display Size(mm):1018.08(H)X572.67(V) ■ Pixel Pitch (mm):0.63(H)x0.63(V) ■ Response Time:8ms(typ.) ■ Brightness:500nit ■ Viewing Angle:178° (vertical/level) ■ Color:1.07B/10Bit ■ Field Frequency:60Hz ■ Material of Shell:Sheet Metal 	₱50,278	₱37,709
GNT-PL55B35		55" LED Splicing Screen (Half Cover) <ul style="list-style-type: none"> ■ Splicing Gap:3.5mm ■ Backlight Type:LED ■ Resolution:1920*1080 ■ Display Size(mm):1209.6(H)X680.4(V) ■ Pixel Pitch (mm):0.63(H)x0.63(V) ■ Response Time:8ms(typ.) ■ Brightness:<500nit ■ Viewing Angle:178° (vertical/level) ■ Color:1.07B/10Bit ■ Field Frequency:60Hz ■ Material of Shell:Sheet Metal 	₱55,706	₱41,779
GNT-PL55Q35		55" LED Splicing Screen (Full Cover) <ul style="list-style-type: none"> ■ Splicing Gap:3.5mm ■ Backlight Type:LED ■ Resolution:1920*1080 ■ Display Size(mm):1209.06(H)X680.4(V) ■ Pixel Pitch (mm):0.63(H)x0.63(V) ■ Response Time:8ms(typ.) ■ Brightness:500nit ■ Viewing Angle:178° (vertical/level) ■ Color:1.07B/10Bit ■ Field Frequency:60Hz ■ Material of Shell:Sheet Metal 	₱57,549	₱43,162
GNT-PL55Q18		55" LED Splicing Screen (Full Cover) <ul style="list-style-type: none"> ■ Splicing Gap:1.8mm ■ Backlight Type:LED ■ Resolution:1920*1080 ■ Display Size(mm):1209.06(H)X680.4(V) ■ Pixel Pitch (mm):0.63(H)x0.63(V) ■ Response Time:8ms(typ.) ■ Brightness:<500nit ■ Viewing Angle:178° (vertical/level) ■ Color:8Bit(16.7M) ■ Field Frequency:60Hz ■ Material of Shell:Sheet Metal 	₱111,104	₱83,328